

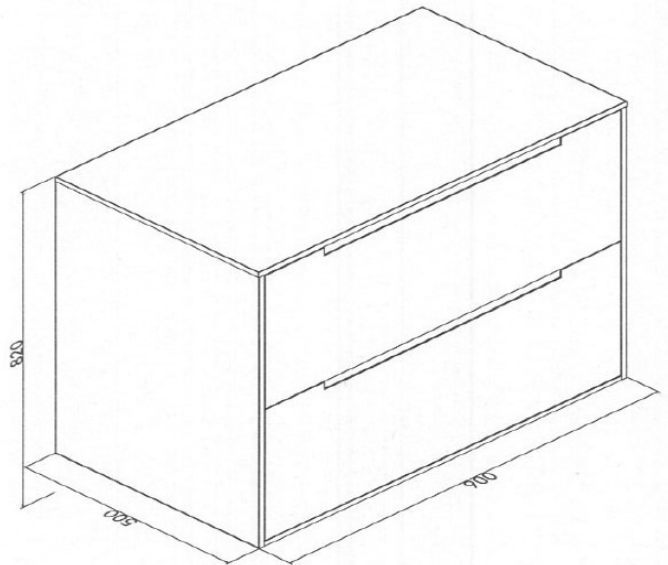

RADLEY PLUS 900 M11

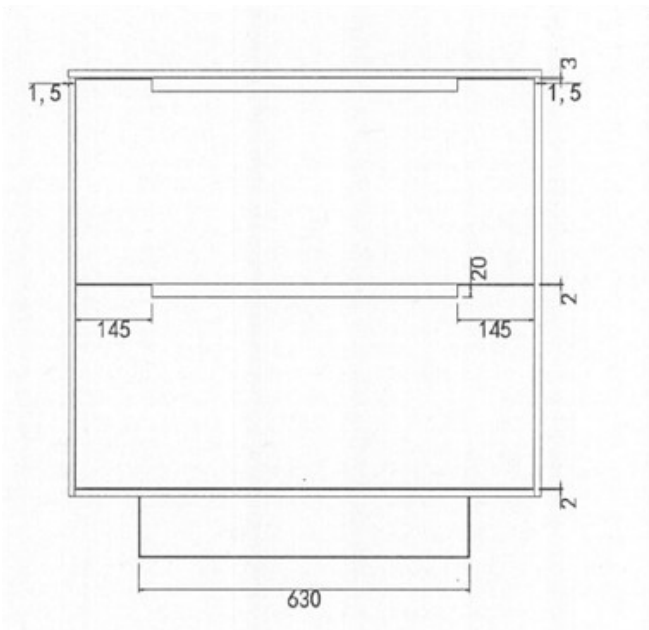

PRODUCT CODE	RKL90M11	WARRANTY	12 MONTHS
DIMENSIONS	900WX500DX820H	STYLE	FLOOR/WALL HUNG WITH CONCEALED REMOVABLE KICKER
BRAND	FREDERIC		
FINISH	2 PACK WHITE GLOSS DRAWERS/ TOP & SIDE PANEL M11 FINISH		

Please note that these dimensions will vary by a few millimeters and DRJ AUSTRALIA PTY LTD is not liable if the installer uses the specifications to rough in, this is only a guide only. DRJ advises to have the DRJ product onsite when roughing in, this will assure the job is done correctly and accurately. Any information in regards to installation, please contact DRJ AUSTRALIA PTY LTD on:

(03) 9768 2222

sales@drj.com.au