

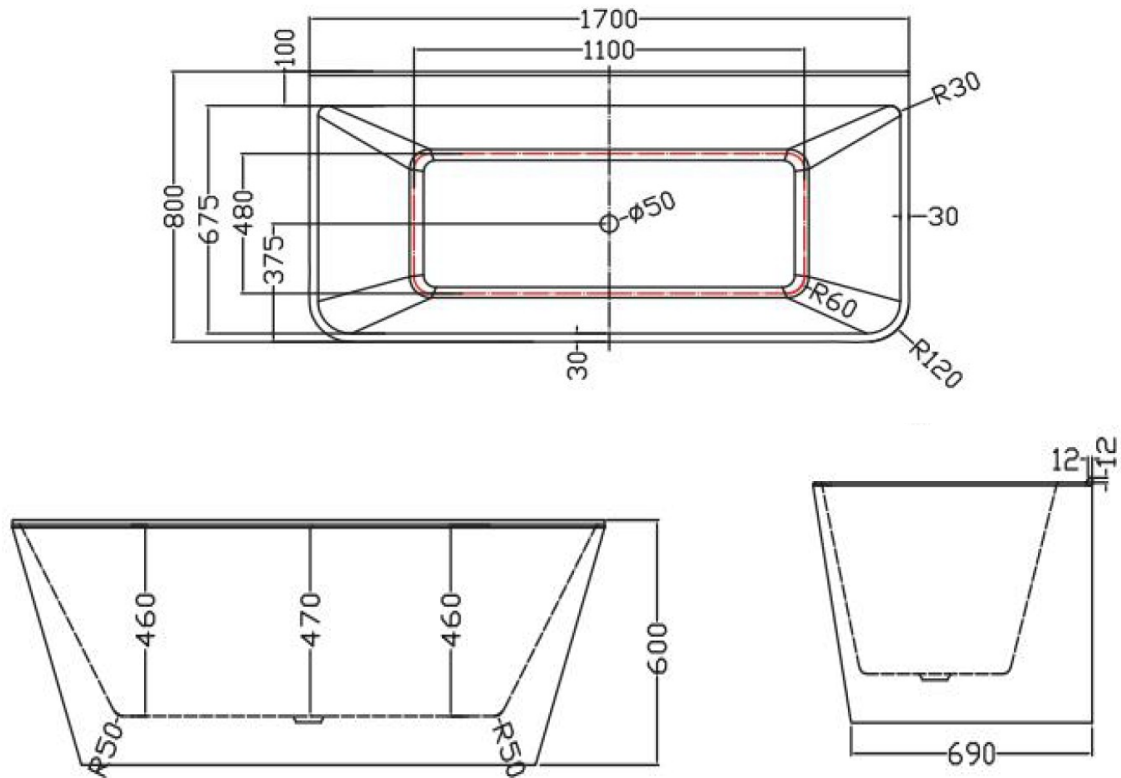

MIKASA FREESTANDING BATH



PRODUCT CODE	MBFSB17	STYLE	BACK TO WALL
DIMENSIONS	1700X800X600	WARRANTY	5 YEAR PRODUCT REPLACEMENT & 1 YEAR PARTS & LABOR
BRAND	FREDERIC	MATERIAL	SANITARY GRADE 4MM GAUGE ACRYLIC
FINISH	BLACK GLOSS		
WASTE SIZE	40MM		

Please note that these dimensions will vary by a few millimeters and DRJ AUSTRALIA PTY LTD is not liable if the installer uses the specifications to rough in, this is only a guide only. DRJ advises to have the DRJ product onsite when roughing in, this will assure the job is done correctly and accurately. Any information in regards to installation, please contact DRJ AUSTRALIA PTY LTD on:

(03) 9768 2222

sales@drj.com.au